

# Cuisinart®

## INSTRUCTION AND RECIPE BOOKLET



**POWERSELECT™ Electronic Hand Mixer**

**CHM-3**

For your safety and continued enjoyment of this product, always read the instruction book carefully before using.

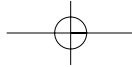

## TABLE OF CONTENTS

Important Safeguards ..... 2  
 Introduction ..... 2  
 Features and Benefits ..... 3  
 Use and Care ..... 4  
 Quick Reference Chart ..... 4  
 Recipes ..... 4  
 Warranty .....15

## IMPORTANT SAFEGUARDS

When using an electrical appliance, basic safety precautions should always be followed including the following:

1. **Read all instructions.**
2. To protect against risk of electrical shock, do not put the hand mixer or cord in water or other liquid. If hand mixer or cord falls into liquid, unplug the cord from outlet immediately. Do not reach into the liquid.
3. To avoid possible accidental injury, close supervision is necessary when any appliance is used by or near children.
4. Unplug from outlet when not in use, before putting on or taking off parts, and before cleaning.
5. Avoid contact with moving parts. Keep hands, hair, clothing, as well as spatulas and other utensils away

- from beaters during operation to reduce risk of injury to persons, and/or damage to the mixer.
6. Remove beaters from the mixer before washing.
  7. Do not operate any appliance with a damaged cord or plug after the appliance malfunctions, or is dropped or damaged in any manner. Return appliance to the nearest authorized Cuisinart service facility for examination, repair, or mechanical or electrical adjustment.
  8. The use of attachments not recommended by Cuisinart may cause fire, electrical shock, or risk of injury.
  9. Do not use outdoors or anywhere the cord or mixer might come into contact with water while in use.
  10. To avoid possibility of mixer being accidentally pulled off work area, which could result in damage to the mixer or in personal injury, do not let cord hang over edge of table or counter.
  11. To avoid damage to cord and possible fire or electrocution hazard, do not let cord contact hot surface, including the stove.

## SAVE THESE INSTRUCTIONS

## FOR HOUSEHOLD USE ONLY

### NOTICE

This appliance has a polarized plug (one prong is wider than the other). As a safety feature, this plug will fit into a polarized outlet only one way. If the plug does not fit fully into the outlet, reverse the plug. If it still does not fit, contact a qualified electrician. Do not modify the plug in any way.

### INTRODUCTION

All your mixing tasks just got easier! This PowerSelect™ Electronic Hand Mixer lets you whip up all your favorites – from lighter-than-air meringues to creamy mashed potatoes to substantial cookie doughs. The speed control dial slides into position with one touch, to make operation just about as easy as it gets. Beaters eject to clean up, and the cord rotates to stay out of your way. Everything you need for your mixing convenience.

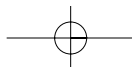

## FEATURES AND BENEFITS

### 220 Watts of Power

Powerful enough to easily cut through a double batch of cookie dough or butter right out of the refrigerator.

### Maximum Comfort

Balanced to do more work for you. The shape of the unit allows maximum possible power and balance. Stress-free grip provides unparalleled comfort and control, even during extended mixing.

### Automatic Feedback

No need for a power boost. An electronic feedback mechanism automatically feeds in extra power when needed. It assures that the mixer will not bog down, even when mixing heavy loads.

### 1. Speed Control

Provides fingertip control of all speeds.

### 2. Exclusive Rotating Swivel Cord

Unique swivel cord can be positioned for comfort with right- or left-handed use. (Patent pending)

### 3. Spatula Included

### 4. Beater Release Button

Conveniently located for easy ejection of beaters.

### 5. Extra-Long Beaters

Two extra-long, extra-wide beaters for superior, faster aerating, mixing, and whipping. Designed with no center post to prevent ingredients from clogging up beaters. Beaters are easy to clean and dishwasher-safe.

### 6. Heel Rest

Allows mixer to rest squarely on countertop.

### 7. Easy To Clean (not shown)

The PowerSelect™ Mixer has a smooth, sealed base; it wipes clean instantly.

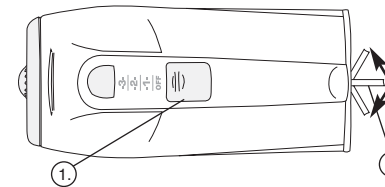
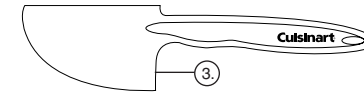
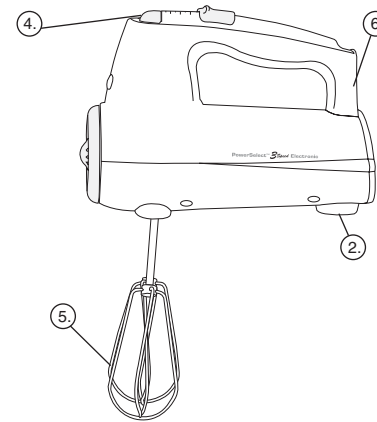

## USE AND CARE

### Inserting Beaters

1. Unplug the mixer and set the speed control to the OFF position.
2. Insert beater with collar into larger hole. Push beater in until it clicks into place. Insert the beater without collar into the smaller hole. Push beater in until it clicks into place.

### Cleaning and Removing Beaters

1. Before cleaning the PowerSelect™ Mixer, set the speed control switch to OFF and unplug it from the wall outlet. Press down on the beater eject button and remove beaters from the mixer. Wash the beaters after each use in hot, soapy water or in a dishwasher.
2. **NEVER PUT THE MOTOR HOUSING IN WATER OR OTHER LIQUID TO CLEAN.** Wipe with a damp cloth or sponge. Do not use abrasive cleansers, which could scratch the surface.

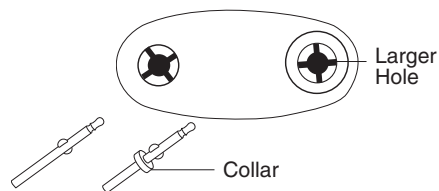

## QUICK REFERENCE CHART

### Mixing Techniques

The PowerSelect™ Mixer should always be set on the lowest speed when you start mixing.

#### Speed 1

- Start mixing most ingredients together
- Combine dry ingredients
- Cream butter and sugar to mix
- Mix heavy cookie doughs
- Mash potatoes/squash
- Add nuts, chips, dried fruit to doughs and batters
- Add flour to batters, or liquids to dry ingredients
- Start mixing frostings
- Start mixing cake mixes
- Add eggs to batters/doughs
- Start to whip potatoes/squash
- Mix pudding batters

#### Speed 2

- Complete beating cake mixes
- Mix scratch cake batters
- Cream butter and sugar until light and fluffy
- Complete mixing frostings
- Whip potatoes/squash
- Beat whole eggs/yolks
- Whip cream

#### Speed 3

- Whip egg whites
- Complete whipping cream
- Whip butter or cream cheese to light and fluffy consistency for dips and spreads

## RECIPES

### Mixing Tips

- Always read entire recipe and measure all ingredients before beginning the mixing process.
- For best results, do not measure flour directly from the bag. Pour into a container or bowl, scoop out the flour and level with the back of a knife or spatula. For flour stored in a container, stir before measuring.
- Eggs, butter or cream cheese combine more thoroughly at room temperature.
- Remove butter for recipe first and cut into ½-inch pieces, then measure out remaining ingredients for recipe. This will hasten the warming process. Do not warm butter for baking in a microwave unless instructed to do so. Microwaving can melt butter; melted butter will change the final product.
- The best cheesecakes are made when the eggs and cream cheese are a similar room temperature. While the Cuisinart® hand mixer can easily mix cold cream cheese, the trick is

not to add too much air, which can cause cracking.

- For best results, use heavy cream, cold from the refrigerator, for whipped cream.
- For best results, whip egg whites in a spotlessly clean stainless steel or glass mixing bowl. If available, use a copper mixing bowl. Chocolate chips, nuts, raisins, etc. can be added using speeds 1 or 2 of your hand mixer.
- To separate eggs for any recipe, break them one at a time into a small bowl, gently remove yolks, then transfer egg whites to spotlessly clean mixing bowl. If a yolk breaks into the egg white, reserve that one for another use. Just a drop of egg yolk in the white will prevent the whites from whipping properly.
- To achieve the best volume when whipping egg whites, the mixing bowl and beaters must be spotlessly clean and free of any fat, oil, etc. (Plastic bowls are not recommended for whipping egg whites.) The presence of any trace of fat or oil will prevent the egg whites from increasing in volume. Wash bowl and attachments thoroughly before beginning again.
- Occasionally ingredients may stick to the sides of the mixing bowl. When this occurs, turn mixer off and scrape the sides of the bowl with a rubber spatula.

## SWEETS

### Cinnamon Muffins

*These tasty muffins are just right for a holiday bread basket.*

Makes 12 regular or 24 mini muffins

- cooking spray**
- 2 cups unbleached all-purpose flour**
- 3 tablespoons brown sugar, packed**
- 1 tablespoon baking powder**
- 1 teaspoon cinnamon**
- ¼ teaspoon salt**
- 2 large eggs**
- 1 cup evaporated skimmed milk (not reconstituted), or whole milk**
- ¼ cup unsalted butter, melted and cooled**

Preheat the oven to 375°F. Spray 12 regular or 24 mini muffin cups.

Place the flour, brown sugar, baking powder, cinnamon, and salt in a medium bowl. Mix on Speed 1 for 30 seconds to combine and break up brown sugar; reserve.

Place the eggs in a second bowl. Beat on Speed 2 until slightly foamy, 30 seconds. Then, mixing on Speed 3, add the milk and melted butter; mix for 15 seconds. Pour over the dry ingredients, and use Speed 1 to stir in until the ingredients are just moistened. Scoop into the prepared muffin cups.

Bake in the preheated oven: 18–20 minutes for regular muffins, 14–16 minutes for mini muffins, until lightly browned and springy to touch in the center. Serve warm with Maple Orange Butter. (Muffins may be made ahead and frozen. Thaw and warm before serving.)

*Nutritional information per serving (1 regular or 2 mini muffins):*  
*Calories 155 (29% from fat) • carb. 22g*  
*• pro. 5g • fat 5g • sat. fat 2g • chol. 46mg*  
*• sod. 208mg • calc. 141mg • fiber 1g*

### Maple Orange Butter

*Maple Orange Butter also makes a great spread for pancakes, waffles, biscuits or scones.*

Makes ¾ cup

- ½ cup unsalted butter, room temperature**
- 2 tablespoons maple syrup (not pancake or sugar syrup)**
- zest of 1 orange, finely chopped**

Use Speed 3 to beat butter in a mixing bowl until light and fluffy, about 1 minute. Add maple syrup and orange zest; beat on Speed 3 for 1 minute longer until fluffy and completely combined.

*Nutritional information per serving (1 tablespoon):*  
*Calories 76 (88% from fat) • carb. 2g*  
*• pro. 0g • fat 8g • sat. fat 5g • chol. 21mg*  
*• sod. 1mg • calc. 6mg • fiber 0g*

## Double Chocolate Walnut Brownie Drops

*A brownie in a bite!*

Makes 26

- 2 ounces unsweetened chocolate, chopped**
- 1½ cups all-purpose flour**
- ½ teaspoon baking powder**
- ½ teaspoon salt**
- 8 tablespoons unsalted butter, cut in 8 pieces**
- ½ cup granulated sugar**
- ½ cup brown sugar, firmly packed**
- 1 large egg**
- 1½ teaspoons vanilla extract**
- ¾ cup mini chocolate morsels**
- ¾ cup chopped walnuts**
- powdered sugar for garnish**

Melt the chocolate in a double boiler over hot water or in a microwave according to manufacturer's directions. Let cool. Preheat oven to 350°F. Line baking sheets with parchment or nonstick baking liner sheets.

Place the flour, baking powder and salt in a medium bowl; mix on Speed 1 for 20 seconds to combine. Reserve.

Place the butter and sugars in a medium bowl. Mix on Speed 1 for 30 seconds, then mix on Speed 3 until light and fluffy, 2 minutes. Add the egg and vanilla, mixing on Speed 2 until combined, 20 seconds. Add melted,

cooled chocolate, mix 20 seconds on Speed 1. Add flour mixture, mix on Speed 1 until combined, 30 seconds. Add chocolate morsels and walnuts, mix on Speed 1 to blend, 10 seconds.

Scoop out dough in 1½ tablespoon amounts onto prepared baking sheets. (For ease, speed and uniformity, you may use a #40 ice cream scoop.) Bake in the preheated oven for 10–12 minutes. Let cool on pans 2 minutes, then transfer to a wire rack to cool completely. Just before serving, dust lightly with powdered sugar if desired.

*Nutritional information per serving:*  
*Calories 151 (48% from fat) • carb. 18g*  
*• pro. 2g • fat 8g • sat. fat 4g • chol. 18mg*  
*• sod. 59mg • calc. 15mg • fiber 1g*

## Oatmeal Monster Cookies

*These yummy cookies may just become your all-time favorites. They are loaded with goodies and sure to wow family and friends.*

Makes 5 dozen cookies

- 2 cups all-purpose flour**
- 1½ teaspoons baking soda**
- 1 teaspoon salt**
- 1½ cups butter**
- 1½ cups light brown sugar**
- 1½ cups sugar**
- 2 large eggs**
- 1½ teaspoons vanilla extract**
- 4 cups quick-cooking oats**
- ¾ cup chopped pecans**

- ¾ cup chocolate chips (semisweet or milk)**
- ¾ cup Bits O'Brickle® or shredded coconut**
- ¾ cup M&M® candies**
- ¾ cup raisins, dried cranberries or dried tart cherries**
- cooking spray**

Preheat oven to 350°F. Combine flour, soda and salt in a small bowl; reserve.

In a large mixing bowl, cream butter and sugars on Speed 1 until light and fluffy, about 1–2 minutes. Add eggs and vanilla; beat on Speed 1 until well blended, about 1 minute.

Add flour mixture to creamed mixture in 4 additions; beat on Speed 1 after each addition until well blended. Add oats in 4 additions; beat on Speed 2 after each addition until well mixed. Add pecans and continue beating on Speed 1 until just blended. Add chocolate chips and next 3 ingredients; continue mixing on Speed 1 until well blended, about 20–30 seconds.

Spray baking sheets with cooking spray or line with parchment paper. Drop dough by rounded tablespoons, 2 inches apart, onto baking sheet and bake until golden brown, about 10–12 minutes. Remove from baking sheet and cool on wire rack.

*Nutritional information per cookie:*  
**Calories 165 (40% from fat) • carb. 23g**  
 • prot. 2g • fat 7g • sat. fat 4g • chol. 18mg  
 • sod. 91mg • calc. 25mg • fiber 1g

*Bits O'Brickle® is a registered trademark owned by the Hershey Chocolate and Confectionery Group.  
 M&M's® is a registered trademark owned by Mars, Inc.*

## Lemon-Lime Sugar Cookies

*Cookies with a little "zest"!*

Makes 50 cookies

- 4 cups all-purpose flour**
- 2 teaspoons baking soda**
- ½ teaspoon salt**
- ½ cup (1 stick) unsalted butter, cut in 8 pieces**
- 2½ cups granulated sugar, divided**
- ½ cup Lyle's Golden Syrup® (may use light corn syrup)**
- 2 large eggs**
  - zest of 1 lemon (bitter white pith removed), finely chopped**
  - zest of 1 lime (bitter white pith removed), finely chopped**
- 1 teaspoon lemon extract**
- 1 teaspoon lime extract**

Preheat oven to 350°F. Line baking sheets with parchment.

Place the flour, baking soda, and salt in a medium bowl. Use Speed 1 to blend and aerate, 20 seconds. Reserve.

Place the butter and 2 cups of the

sugar in a large bowl. Use Speed 1 to blend, 30 seconds. Cream until light and fluffy using Speed 3, 1½ minutes. Add syrup, eggs, and zests. Mix on Speed 2 for 30–40 seconds until smooth. Add extracts; mix on Speed 1 for 30 seconds.

Using 1½ tablespoons of dough, shape into round balls and dip in remaining sugar to coat. (For ease and speed, use a number 40 ice cream scoop.) Arrange balls on parchment-lined baking sheet 2½ inches apart. Press each ball gently with the bottom of a flat glass. Bake in preheated 350°F oven for 10–12 minutes, until crackled and just beginning to turn golden. Remove from oven, let cool on baking sheet for 2–3 minutes, then transfer to a wire rack to cool completely. Store between sheets of waxed paper in an airtight container.

Tip: to chop zest easily, place zest in workbowl of a Cuisinart® MiniPrep Plus with ¼ cup of the sugar from the recipe. Pulse on chop 10–15 times, then process continuously until finely chopped, 30–40 seconds.

*Nutritional information per cookie:*  
**Calories 116 (31% from fat) • carb. 19g**  
 • pro. 1g • fat 15g • sat. fat 2g • chol. 13mg  
 • sod. 72mg • calc. 5mg • fiber 0g

*Cuisinart® is a registered trademark of Cuisinart, Stamford, CT.  
 Lyle's Golden Syrup® is a registered trademark owned by Tate and Lyle Industries Ltd.*

## Mocha Chocolate Chip Cookies

*Serve these delicious cookies with ice cream for a special dessert or with a glass of milk for a late night snack.*

Makes 3½ dozen cookies

- 1½ tablespoons instant coffee granules**
- 1 tablespoon hot water**
- 2 cups all-purpose flour**
- 1¼ teaspoons baking soda**
- ¼ teaspoon salt**
- 1 cup butter, slightly softened**
- ¾ cup firmly packed light brown sugar**
- ¾ cup sugar**
- 1 large egg**
- 1¼ teaspoons vanilla extract**
- 1½ cups semi-sweet chocolate chips**
- 1 cup chopped pecans, toasted**
- cooking spray**

Preheat oven to 350°F. Combine instant coffee granules and water in a small bowl; reserve. Combine flour, soda and salt in a small bowl; reserve.

In a large mixing bowl, cream butter and sugars on Speed 2 until light and fluffy, about 1–2 minutes.

Add coffee/water mixture, egg and vanilla; and mix until well blended, about 30 seconds.

Add flour mixture; mix on Speed 1 until combined, about 30 seconds. Scrape bowl with a spatula and continue mixing until well blended, about 30 seconds. Add chocolate chips and pecans; mix

on Speed 1 until just combined, about 20–30 seconds.

Spray baking sheets with cooking spray or line with parchment paper. Drop by rounded tablespoons, 2 inches apart, onto baking sheets. Bake until golden, about 10–12 minutes. Cool slightly on baking sheet and then transfer to a wire rack.

*Nutrition information per cookie:*  
*Calories 155 (50% from fat) • carb. 18g*  
*• pro. 1g • fat 9g • sat. fat 9g • chol. 22mg*  
*• sod. 52mg • calc. 8 mg • fiber 2g*

### Meringue Kisses

*Light as a cloud, these sweet little kisses are just the thing when the sweet tooth bites.*

Makes 36

- 1 **tablespoon butter, melted**
- 2 **tablespoons powdered sugar**
- 4 **large egg whites**
- $\frac{1}{2}$  **teaspoon cream of tartar**
- $\frac{3}{4}$  **cup granulated sugar**  
(superfine is best)
- 1 **teaspoon vanilla or almond extract**
- 2 **ounces chopped semi-sweet or**  
**bittersweet chocolate ( $\frac{1}{8}$ -inch chop)**

Preheat oven to 225°F. Line 2 baking sheets with parchment paper. Brush the parchment lightly with the melted butter, then dust with powdered sugar, shaking off excess sugar.

Place the egg whites and cream of tartar in a medium mixing bowl. Start mixing the egg whites and cream of tartar on Speed 1, increasing gradually to Speed 3. Whip until soft peaks form,  $1\frac{1}{2}$  to 2 minutes (depending on temperature of egg whites). Sprinkle sugar 1 tablespoon at a time over egg whites and beat on Speed 3 after each addition, until stiff peaks form and mixture is shiny but not dry, about 4 minutes total.

Add the vanilla and beat on Speed 1 to blend in, 10 seconds.

Using a clean rubber spatula, fold in chopped chocolate. Drop meringue mixture by rounded tablespoons onto prepared baking sheets, or gently place it in a large pastry bag fitted with a  $\frac{3}{8}$ -inch plain tip and pipe out “kisses”. Bake in preheated oven for  $1\frac{1}{2}$  hours; do not peek. Turn off oven and let sit in warm oven for an additional  $1\frac{1}{2}$  hours to dry out. Transfer to a wire rack to cool completely. Store in an airtight container.

*Nutritional information per “kiss”:*  
*Calories 26 (19 from fat) • carb. 5g*  
*• pro. 0g • fat 1g • sat. fat. 0g • chol. 0mg*  
*• sod. 8mg • calc. 1mg • fiber 0g*

**Tip:** Meringues are best when made on dry day.

#### To make “nests” for mousse:

Draw 3-inch circles on the underside of parchment sheet. Butter and dust upper side with powdered sugar. Pipe concen-

tric circles of meringue into the 3-inch rounds. Pipe another 2 circles on the outermost edge of the meringues. Bake as directed, but increase the baking and resting time to 2 hours. Makes 4.

### Apple Cranberry Coffee Cake

*This versatile cake can be served as a breakfast or brunch cake, or warmed for dessert and topped with a scoop of vanilla ice cream or softly whipped cream.*

Makes 18–24 servings

- 3 cooking spray**
- 3 cups sliced apples \***  
(peel, core, quarter apples, cut into  $\frac{1}{8}$ -inch slices)
- $\frac{3}{4}$  juice of 1 lemon**
- 1 cup brown sugar, firmly packed**
- $\frac{1}{2}$  tablespoon ground cinnamon**
- $\frac{1}{2}$  teaspoon freshly grated nutmeg**
- $\frac{1}{2}$  cup dried cranberries**  
(may substitute dried cherries, blueberries or raisins)
- 3 cups all-purpose flour**
- 1 tablespoon baking powder**
- $\frac{3}{4}$  teaspoon salt**
- 2 cups granulated sugar**
- 1 cup unsalted butter, cut into**  
 **$\frac{1}{2}$ -inch pieces**
- 4 large eggs**
- 2 teaspoons vanilla extract**

Preheat oven to 350°F. Lightly coat a 13x9x2-inch rectangular baking pan



(15-cup) with cooking spray. Place the apples, lemon juice, brown sugar, cinnamon, nutmeg, and dried cranberries in a medium bowl. Toss gently to combine; reserve.

Place the flour, baking powder, and salt in a medium bowl. Mix on Speed 1 to blend and aerate, 15 seconds; reserve. Blend the sugar and butter in a large bowl. Mix on Speed 1 to cream until well blended, 1 minute. Add eggs and vanilla; mix on Speed 2 until smooth and creamy, about 50 seconds. Add the flour mixture; mix on Speed 1 until combined and smooth, 1 minute. Batter will be very thick. Spread two thirds of the batter in the prepared pan. Top evenly with the apple and cranberry mixture. Spoon the remaining batter randomly over the top of the apple mixture. Bake in preheated oven for 55–60 minutes, until a tester inserted in the center comes out clean. Cool in pan on a wire rack for at least 30 minutes before cutting.

\* About 1½ pounds apples before trimming.

*Nutritional information per serving (24 pieces):*  
*Calories 253 (31% from fat) • carb. 56g*  
*• pro. 3g • fat 9g • sat. fat 5g • chol. 75mg*  
*• sod. 151mg • calc. 31mg • fiber 2g*

## Cappuccino Cheesecake

*Coffee and dessert, all in one!*

Makes 12–16 servings

- 2**    **tablespoons instant espresso powder**
- ½**    **cup half-and-half**
- cooking spray**
- 3**    **tablespoons unsalted butter,**
- cut in ½-inch pieces**
- 2½**   **cups granulated sugar, divided**
- ¾**    **cup all-purpose flour**
- ¼**    **cup unsweetened cocoa**
- ½**    **teaspoon cinnamon**
- ¼**    **teaspoon baking powder**
- ¼**    **teaspoon salt**
- 1**    **large egg yolk**
- 16**   **ounces cream cheese (regular),**
- at room temperature**
- 16**   **ounces lowfat cream cheese, at**
- room temperature**
- 4**    **large eggs, not cold from refrigerator\***
- 2**    **tablespoons cornstarch**
- 2**    **teaspoons vanilla extract**
- chocolate curls for garnish, optional**

In a small bowl dissolve the espresso powder in the half-and-half; reserve. Preheat oven to 350°F. Lightly coat a 9 x 3-inch springform or cheesecake pan with cooking spray.

Place the butter and ¼ cup of the sugar in a medium bowl. Mix on Speed 2 to cream, 1½ minutes. Add flour, cocoa, cinnamon, baking powder, and salt; mix on Speed 1 until combined, 30

seconds. Add egg yolk and mix on Speed 1 until crumbly, 15 seconds. Press into bottom of prepared pan. Bake in preheated oven for 10 minutes, until slightly puffed (crust may have cracked appearance – that is normal). Place on a rack to cool. When the pan is cool to touch, wrap a sheet of aluminum foil around the bottom and sides of the pan so that it comes up at least 2 inches.

Place cream cheeses and sugar in a large mixing bowl. Beat on Speed 1 until combined and smooth, 2 minutes. Using Speed 1, add eggs, one at a time, mixing for 15 seconds after each addition. Scrape the bowl. Add cornstarch; mix on Speed 1, 20 seconds. Scrape the bowl. Add half-and-half mixture and vanilla, mix on Speed 1 until smooth and completely combined.

Pour the mixture over the cooled crust. Place the pan in a larger aluminum pan and place in the oven; add enough hot water to the outer pan so that it is ½-inch deep. Bake in the preheated 350°F oven for 60–70 minutes, until the cheesecake is pulling away from the sides of the pan; the center will be jiggly. Remove from the oven, remove the foil and let cool completely on a rack.

Refrigerate at least 4 hours before serving. Garnish with chocolate curls if desired.

\*Warm cold eggs safely before using by placing in a bowl of hot (not boiling) water for 10 minutes. They will incorporate more easily into your mixture.

*Nutritional information per serving (16 servings):*  
 Calories 368 (48% from fat) • carb. 41g  
 • pro. 8g • fat 20g • sat. fat 12g • chol. 116mg  
 • sod. 290mg • calc. 89mg • fiber 1g

#### Variation:

After the cheesecake is mixed, add 3 ounces each chopped white and bittersweet chocolate using Speed 1, mix for 15 seconds to combine.

### Sunshine Chiffon Cake

*Chiffon cakes are made with oil rather than butter or shortening, making them moist and light in texture. With flecks of fresh citrus, this one is good on its own, or served with sliced fresh fruit.*

Makes 16 to 20 servings

- 7 large eggs, separated**
- 1 teaspoon fresh lemon juice**
- 1½ cups granulated sugar, divided**
- 2 cups unbleached all-purpose flour \***
- 1 tablespoon baking powder**
- ¼ teaspoon salt**
- 1 tablespoon finely chopped lemon zest**
- 1 tablespoon finely chopped orange zest**
- ¾ cup fresh orange juice**

- ½ cup flavorless vegetable oil (or use a nut oil such as almond or walnut)**
- 1½ teaspoons vanilla extract**
- 1 teaspoon almond extract**
- powdered sugar for dusting, or Orange Apricot Glaze**

Preheat oven to 325°F. Have ready a 10-inch angel food or tube pan (preferably one that is one piece).

Place the egg whites in a large, clean stainless or glass mixing bowl. Using Speed 3, whip egg whites until frothy and foamy, about 30 seconds, then add lemon juice. Continue to whip until thick and opaque, about 3 minutes, adding ½ cup of the sugar gradually to the egg whites. Continue to whip until stiff and glossy, about 7 minutes total. Reserve.

Place the remaining 1 cup of the sugar, the flour, baking powder, and salt in a large mixing bowl. Insert mixing beaters. Mix on Speed 1 to blend and aerate, 10 seconds. Place the egg yolks, zests, juice, oil, and extracts in a medium bowl. Mix on Speed 2 for 30 seconds; scrape the bowl. Make a well in the center of the dry ingredients. Add the liquid/yolk mixture and mix using Speed 2 until batter is smooth, about 1 minute.

Stir 1 cup of the egg whites into the batter using a spatula, then gently fold the remaining egg whites into the

batter one third at a time. Gently spoon into the prepared pan and bake in the preheated oven for 60 minutes, until a cake tester comes out clean when tested. Invert the pan immediately onto a wire rack and let the cake cool completely in the pan upside down on the rack. This will take about 2½ to 3 hours.

Run a long thin knife around the outer and tube edges of the pan and turn the cake out of the pan onto the rack. Use a long wooden skewer to loosen the cake from the center tube. Remove cake from pan. Wrap in plastic wrap and store at room temperature for up to 2 days or refrigerate up to 4 days. (Cake may be also be double-wrapped and frozen – thaw before serving.) Dust with powdered sugar before serving – serve with a drizzle of the Orange Apricot Glaze.

*Nutritional information per serving (based on 18 servings):*  
 Calories 194 (37% from fat) • carb. 27g  
 • pro. 3g • fat 10g • sat. fat 1g • chol. 83mg  
 • sod. 282mg • calc. 93mg • fiber 0g

\* Stir flour, then spoon into measuring cup. Level off with the back of a table knife or spatula.

### Orange Apricot Glaze

*A good way to sweeten your chiffon cake.*

Makes ½ cup glaze

- ½ cup apricot preserves
- 2 tablespoons Grand Marnier®
- 1 teaspoon fresh lemon juice

Place preserves, liqueur and lemon juice in a small bowl. Insert the mixing beaters. Mix on Speed 3 for 1 minute. May use as is, or for a smoother glaze, press through a strainer.

*Nutritional information per serving  
(about 1½ teaspoon):*

*Calories 28 (1% from fat) • carb. 7g  
• pro. 0g • fat 0g • sat. fat 0g • chol. 0mg  
• sod. 4mg • calc. 2mg • fiber 0g*

*Grand Marnier® is a registered trademark owned by the Societe des Produits Marnier - LaPostolle Joint Stock Co.*

## Savories

### Herbed Cheese

*Instead of purchasing expensive herb-flavored cheeses, you can easily prepare your own.*

Makes about 2 cups

- 8 ounces cream cheese (may use regular or lowfat)
- 5 ounces chèvre or other goat cheese (soft type, not aged)
- 1 clove garlic, peeled and minced

- 1 tablespoon finely minced shallot or green onion
- 1 tablespoon finely chopped fresh parsley
- 1 teaspoon herbs de Provence
- ½ teaspoon kosher salt
- ¼ teaspoon white pepper
- dash hot sauce such as Tabasco®, to taste

Place all ingredients except hot sauce in a medium bowl. Mix on Speed 2 for 1 minute, then increase speed to Speed 3 to whip for an additional 2 minutes until light and fluffy. Add hot sauce to taste, whip on Speed 5 for 30 seconds longer. Allow to stand at least 30 minutes before serving, to allow flavors to blend. Transfer to a resealable container and refrigerate. Remove from refrigerator 15 minutes before serving to soften. Serve with crackers, pita or bagel chips. It also makes a good topping for a baked potato.

*Nutritional information per serving  
(2 tablespoons, made with lowfat cream cheese):*

*Calories 58 (69% from fat) • carb. 1g  
• pro. 3g • fat 4g • sat. fat 3g • chol. 9mg  
• sod. 156mg • calc. 35mg • fiber 0g*

*Tabasco® is a registered trademark owned by McIlhenny Co.*

### Roasted Red Pepper and Sun-dried Tomato Dip

*Serve this dip with crackers, bagel chips or pita chips. Or, try it as a spread on sandwiches, or as a topping for baked potatoes.*

Makes 2 cups

- 8 ounces cream cheese (lowfat or regular), cut into 8 pieces
- ½ cup sour cream (lowfat or regular)
- 1 roasted red pepper, cut into 1-inch pieces
- ½ cup chopped sun-dried tomatoes (not oil packed)
- 1 tablespoon chopped fresh parsley
- 1 clove garlic, chopped
- ½ teaspoon basil
- ¼ teaspoon freshly ground black pepper

Combine all ingredients in a medium bowl. Mix on Speed 2 until well blended and smooth, 2 minutes. Mix on Speed 3 to lighten, 1 minute. Transfer to a resealable container and refrigerate for 30 minutes or longer to allow flavors to blend before serving.

*Nutritional information per serving  
(2 tablespoons), made with lowfat products:*

*Calories 54 (52% from fat) • carb. 4g  
• pro. 2g • fat 3g • sat. fat 2g • chol. 7mg  
• sod. 111mg • calc. 43mg • fiber 0g*

**Caramelized Onion Dip***Serve with chips or fresh vegetables.*

Makes 3½ cups

- 4**    **tablespoons unsalted butter**
- 2**    **tablespoons extra virgin olive oil**
- 2**    **cups finely chopped onions**
- ¼**    **teaspoon cayenne pepper**
- 1**    **teaspoon kosher salt**
- ½**    **teaspoon freshly ground black pepper**
- 8**    **ounces lowfat cream cheese, at room temperature, cut into 1-inch pieces**
- ¾**    **cup lowfat sour cream**
- ½**    **cup lowfat mayonnaise**

Heat butter and oil in a large Cuisinart® skillet (12-inch or 5½ quart sauté) using medium heat. Add the chopped onions, cayenne, salt and pepper. Sauté for 10 minutes, stirring occasionally. Reduce the heat to medium-low and cook for an additional 20–25 minutes, until the onions are browned and caramelized. Let cool completely.

Place the cream cheese, sour cream and mayonnaise in a medium bowl. Mix on Speed 1 for 1 minute, then increase speed to Speed 2 for an additional 2 minutes until light and fluffy. Add half the cooled onions, and mix on Speed 3 for 1 minute. Add remaining onions and mix on Speed 1 until blended. Taste and adjust seasonings

as necessary. Serve with chips or fresh vegetable crudité dippers.

*Nutritional information per serving (¼ cup):*  
*Calories 131 (72% from fat) • carb. 6g*  
*• pro. 3g • fat 11g • sat. fat 4g • chol. 21mg*  
*• sod. 308mg • calc. 53mg • fiber 1g*

**Basic Vinaigrette**

*The perfect topping for a crisp green salad, this can be varied by changing the flavor of the oil or vinegar, or by adding herbs.*

Makes about 2 cups

- 1**    **clove garlic, peeled and finely minced**
- 2**    **tablespoons Dijon-style mustard**
- ½**    **cup wine vinegar or lemon juice**
- ½**    **teaspoon kosher salt**
- ¼**    **teaspoon freshly ground pepper**
- 1**    **cup vegetable oil**
- ½**    **cup extra virgin olive oil**

Place the garlic, mustard, vinegar, salt, and pepper in a medium bowl. Mix on Speed 2 until well blended, 30 seconds. With the mixer running, add the oils in a slow steady stream, about 1½ minutes continue to mix until totally blended. (If vinaigrette is made ahead and separation occurs, remix on Speed 3/medium until blended.)

*Nutritional information per serving (1 tablespoon):*  
*Calories 92 (98% from fat) • carb. 1g*  
*• pro. 0g • fat 10g • sat. fat 1g • chol. 0mg*  
*• sod. 54mg • calc. 1mg • fiber 0g*

**Creamy Bleu Cheese Dressing**

*This version is much lower in fat than traditional Bleu Cheese Dressings. Try it as a dip for celery the next time you serve Buffalo-style Wings.*

Makes about 2 cups dressing

- 1**    **clove garlic, peeled and chopped**
- ½**    **ounce shallot, peeled and chopped**
- ½**    **cup lowfat buttermilk**
- 1**    **cup nonfat yogurt**
- ¾**    **cup lowfat mayonnaise**
- ¾**    **teaspoon dry mustard**
- ½**    **teaspoon Worcestershire sauce**
- ¼**    **teaspoon white pepper**
- 3**    **ounces crumbled bleu cheese**
- dash Tabasco® or other hot sauce – to taste**

Place the garlic, shallot, buttermilk, yogurt, mayonnaise, dry mustard, Worcestershire, and pepper in a medium bowl. Mix using Speed 2 until smooth and creamy, 30–40 seconds. Add the crumbled bleu cheese and Tabasco®. Mix using Speed 2 for 20–30 seconds longer. Let stand for 30 minutes before using to allow flavors to develop. Cover and refrigerate all unused portions. Keeps 1 week.

*Nutritional information per serving (4 teaspoons):*  
*Calories 27 (54% from fat) • carb. 1g*  
*• pro. 1g • fat 1g • sat. fat 0g • chol. 2mg*  
*• sod. 47mg calc. 29mg • fiber 0g*

### Garlic & Chive Mashed Potatoes

*Old-fashioned comfort food at its best.  
For Basic Mashed Potatoes, omit  
the garlic and chives.*

Makes 7 cups (12 servings)

- 3** pounds russet or Yukon gold potatoes
- 4–6** cloves garlic, peeled and halved
- 2** teaspoons kosher salt, divided
- 1** teaspoon white wine vinegar
- $\frac{3}{4}$  cup whole milk
- $\frac{1}{2}$  cup half-and-half
- 3** tablespoons unsalted butter
- $\frac{1}{2}$  cup ( $\frac{1}{4}$  ounce) chopped fresh chives
- $\frac{1}{4}$  teaspoon freshly ground white or black pepper

Peel the potatoes and cut in  $\frac{3}{4}$ -inch-thick slices. Place the potatoes, garlic, 1 teaspoon kosher salt, and wine vinegar in a  $3\frac{3}{4}$  quart saucepan\* and cover with cold water by 1 inch. Cover loosely and bring to the boil over high heat, then reduce heat to medium high and boil gently until potatoes are tender but not falling apart, about 18–22 minutes. While potatoes are cooking, combine milk, half-and-half, butter, and  $\frac{1}{4}$  cup of the chives in a Cuisinart®  $1\frac{1}{2}$ -quart saucepan. Simmer over low heat until butter is completely melted. Keep warm.

Drain the cooked potatoes and garlic, return to the saucepan, and place over low heat for 1 minute. Remove from the

heat, and use Speed 1 to mash the potatoes and garlic until somewhat smooth, about 60 seconds. While still mixing, add the hot milk and butter mixture, and mix until well blended, about 30 seconds. Mix on Speed 3 until fluffy, about 1–2 minutes. Add the remaining salt and pepper, mix to blend, 15 seconds. Scrape down sides of pan with rubber spatula as necessary. Transfer the potatoes to a warm serving bowl and sprinkle with the remaining chopped chives. Serve immediately.

*Nutritional information per serving:  
Calories 149 (28% from fat) • carb. 24g  
• pro. 3g • fat 5g • sat. fat 3g • chol. 14mg  
• sod. 185mg • calc. 42mg • fiber 2g*

\* Do not use nonstick cookware with the Cuisinart® Hand Mixer.

**Tip:** For a “lighter” everyday version, use reduced fat or fat-free milk in place of the whole milk and half-and-half.

### Sweet Yam Casserole with Crunchy Pecan Topping

*This easy-to-make casserole can  
be prepared a day ahead to make  
holiday entertaining easier.*

Makes 10 servings

- $1\frac{1}{2}$  cooking spray
- 1** pounds sweet potatoes or yams,

- peeled, cut into 1-inch pieces
- 6** tablespoons ( $\frac{1}{4}$  stick) unsalted butter, room temperature
- 2** large eggs
- $\frac{1}{4}$  cup firmly packed brown sugar
- $\frac{1}{2}$  teaspoon cinnamon
- $\frac{1}{2}$  teaspoon ground ginger
- $\frac{1}{2}$  teaspoon kosher salt
- $\frac{1}{4}$  teaspoon freshly ground black pepper
- $1\frac{1}{2}$  cups cornflakes, crushed
- $\frac{1}{2}$  cup (packed) brown sugar
- $\frac{1}{2}$  cup chopped pecans
- 6** tablespoons ( $\frac{1}{4}$  stick) unsalted butter, melted

If baking immediately after preparing, preheat oven to 400°F. Lightly coat an 8-cup baking dish with cooking spray.

Cook sweet potatoes in large pot of boiling water until tender, about 15 minutes. Drain; transfer potatoes to large bowl and add butter. Mix on Speed 1 for one minute, then increase to Speed 2 and beat until smooth. Add eggs, brown sugar, spices, salt and pepper; beat on Speed 1 to blend, about 30 seconds. Transfer mixture to the prepared baking dish. (Can be made 1 day ahead. Cover and refrigerate.) Bake potatoes in the preheated oven until they are slightly puffed and beginning to brown around the edges, about 25–30 minutes.

While potatoes bake, prepare the

topping by mixing the remaining ingredients in a bowl. Sprinkle the topping evenly over the potatoes and bake about 10 minutes longer, until golden brown and crispy.

*Nutritional information per serving:  
Calories 253 (41% from fat) • carb. 31g  
• pro. 4g • fat 12g • sat. fat 5g • chol. 61mg  
• sod. 202mg • calc. 26mg • fiber 4g*

### Twice-Baked Potatoes with Spinach and Gruyère

*The perfect addition to a baked potato.*

Makes 8 servings

- 8 large (about 10 ounces each) baking potatoes, scrubbed**
- 2 teaspoons olive oil**
- 1 cup evaporated fat-free milk**
- 4 tablespoons unsalted butter, at room temperature, cut in 4 pieces**
- 2 packages (10 ounces each) frozen chopped spinach, thawed and squeezed very dry**
- 6 ounces Gruyère cheese, shredded (do not use processed Gruyère)**
- 6 green onions, finely chopped (include some of the green)**
- $\frac{3}{4}$  teaspoon kosher salt**
- $\frac{1}{2}$  teaspoon freshly ground white or black pepper**

Preheat the oven to 400°F. Pierce each potato several times with a fork or knife

tip; rub each potato with  $\frac{1}{4}$  teaspoon of the olive oil. Bake the potatoes in the preheated oven until fork tender, about 1 hour. When cool enough to handle, cut off the top third of each potato and scoop out the flesh, leaving a  $\frac{1}{4}$ -inch shell. Place potato flesh in large mixing bowl and reserve potato shells.

Add milk and butter to potatoes. Mix on Speed 1 for 1 minute until mashed; mix on Speed 2 for one minute longer. Add spinach, cheese, green onions, salt, and pepper. Mix on Speed 1 until well blended.

Fill the reserved potato shells with the potato-spinach mixture. Potatoes may be made ahead to this point, covered and refrigerated until ready to bake.

Preheat oven to 375°F. Arrange the potatoes on a jelly roll type pan that has been lined with parchment. Bake uncovered until potatoes are hot and tops are golden brown, about 25–30 minutes (add 5–10 minutes for cold potatoes). Serve hot.

*Nutritional information per serving:  
Calories 418 (30% from fat) • carb. 58g  
• pro. 17g • fat 14g • sat. fat 8g • chol. 40mg  
• sod. 305mg • calc. 417mg • fiber 7g*

## Cuisinart® PowerSelect™ Electronic Hand Mixer

### LIMITED THREE-YEAR WARRANTY

This warranty supersedes all previous warranties on the Cuisinart® PowerSelect™ 3-Speed Electronic Hand Mixer. This warranty is available to consumers only. You are a consumer if you own a Cuisinart® PowerSelect™ 3-Speed Electronic Hand Mixer that was purchased at retail for personal, family or household use. Except as otherwise required under applicable state law, this warranty is not available to retailers or other commercial purchasers or owners. We warrant that your Cuisinart® PowerSelect™ 3-Speed Electronic Hand Mixer will be free of defects in material or workmanship under normal home use for three years from the date of original purchase.

We suggest that you complete and return the enclosed product registration card promptly to facilitate verification of the date of original purchase. However, return of the product registration is not a condition of these warranties.

If your Cuisinart® PowerSelect™ 3-Speed Electronic Hand Mixer should prove to be defective within the warranty period, we will repair it, or if we think necessary, replace it.

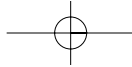

To obtain warranty service, please call our Consumer Service Center toll-free at 1-800-726-0190 or write to:

Cuisinart  
150 Milford Road  
East Windsor, NJ 08520

To facilitate the speed and accuracy of your return, please also enclose \$10.00 for shipping and handling of the product (California residents need only supply proof of purchase and should call 1-800-726-0190 for shipping instructions). Please also be sure to include a return address, description of the product defect, product serial number, and any other information pertinent to the product's return. Please pay by check or money order.

**NOTE:** For added protection and secure handling of any Cuisinart® product that is being returned, we recommend you use a traceable, insured delivery service. Cuisinart cannot be held responsible for in-transit damage or for packages that are not delivered to us. Lost and/or damaged products are not covered under warranty.

Your Cuisinart® PowerSelect™ 3-Speed Electronic Hand Mixer has been manufactured to strict specifications. These warranties expressly exclude any defects or damages caused by accessories, replacement parts or repair service other than those that have been authorized by Cuisinart.

These warranties do not cover any damage caused by accident, misuse, shipment or other than ordinary household use.

These warranties exclude all incidental or consequential damages. Some states do not allow the exclusion of or limitation of incidental or consequential damages, so the foregoing limitation may not apply to you.

#### CALIFORNIA RESIDENTS ONLY

California law provides that for In-Warranty Service, California residents have the option of returning a nonconforming product (A) to the store where it was purchased or (B) to another retail store which sells Cuisinart® products of the same type. The retail store shall then, according to its preference, either repair the product, refer the consumer to an independent repair facility, replace the product, or refund the purchase price less the amount directly attributable to the consumer's prior usage of the product. If either of the above two options does not result in the appropriate relief to the consumer, the consumer may then take the product to an independent repair facility if service or repair can be economically accomplished. Cuisinart and not the consumer will be responsible for the reasonable cost of such service, repair, replacement, or refund for nonconforming products under warranty.

California residents may also, according to their preference, return nonconforming products directly to Cuisinart for repair or,

if necessary, replacement by calling our Consumer Service Center toll-free at 800-726-0190. Cuisinart will be responsible for the cost of the repair, replacement, and shipping and handling for such nonconforming products under warranty.

#### BEFORE RETURNING YOUR CUISINART® PRODUCT

**Important:** If the nonconforming product is to be serviced by someone other than Cuisinart's Authorized Service Center, please remind the servicer to call our Consumer Service Center to ensure that the problem is properly diagnosed, the product serviced with the correct parts, and to ensure that the product is still under warranty.

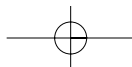
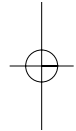

# Cuisinart®

SAVOR THE GOOD LIFE®



Coffeemakers



Food Processors



Toasters



Blenders



Cookware



Ice Cream Makers

Cuisinart offers an extensive assortment of top quality products to make life in the kitchen easier than ever. Try some of our other countertop appliances and cookware, and Savor the Good Life™.

[www.cuisinart.com](http://www.cuisinart.com)

© 2004 Cuisinart  
Cuisinart™ is a registered  
trademark of Cuisinart  
150 Milford Road  
East Windsor, NJ 08520  
Printed in China  
04CU13060

IB-5187